

# Foiled Panels



# Foiled Panels

If you want to decorate your walls with beautiful, muted colors that match the latest design trends, Fog & Venø's foiled panels are the perfect solution for you.

These colored panels are an ideal addition to any modern home, adding charisma to large, open spaces while maintaining a stylish look with their clean lines and Nordic design.

Our foiled acoustic panels are available in a wide range of colors and styles. What makes these panels unique is the foil wrapped around the slats, giving them a solid and minimalist appearance. Foiled panels suit any interior style.

These panels are easy to maintain, as they require no finishing and can easily be wiped clean with a slightly damp cloth.

## With our Foiled panels, you get:

### Creative Freedom

Foiled panels offer endless possibilities to create your own unique expression and design.

### Exclusive Design

An exclusive appearance, produced with a focus on aesthetics and elegance.

### Danish Craftsmanship

Produced in Central Jutland, ensuring a high standard of quality through Danish design and production.

### The Responsible Choice

After their lifespan, the panels can be recycled, highlighting our commitment to responsible design and environmental awareness.

## Features:

- **Local production**  
All panels are produced in Denmark.
- **Attractive square meter price**  
Competitive price per square meter.
- **Quick assembly**  
Easy and quick installation.
- **Minimal use of tools**  
Requires only a few tools for installation and adjustment.
- **Lightweight construction**  
The panels have a low weight, which simplifies handling.
- **Varied surface options**  
Options for different veneer surfaces and core colors.
- **Easy maintenance**  
The wrapped foil makes the panels easy to maintain.
- **Environmentally certified materials**  
FSC™-certified and CARB2-approved MDF.
- **Cleaning**  
Our panels can easily be cleaned with a wrung-out damp cloth.









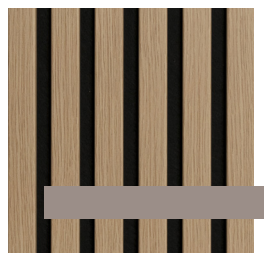
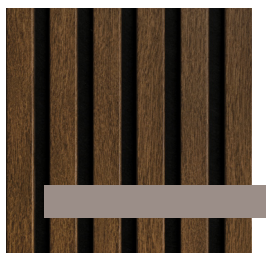
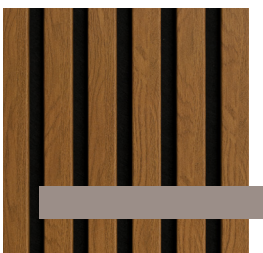
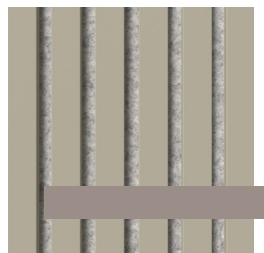
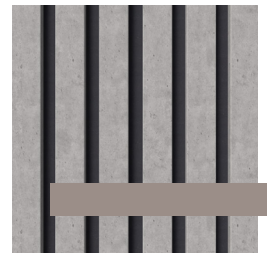
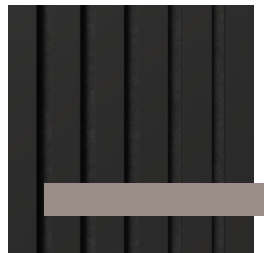

These panels are made from FSC™-certified wood and other controlled materials.  
FSC™ C165957



Sorted as recycled wood.



# Specifications

 Foil	 Core	 Felt	 Dimensions	 m <sup>2</sup> - f <sup>2</sup>	 Weight
Arctic Grey			2400 x 600 x 20 mm - 94.49 x 23.62 x 0.79 in 3000 x 600 x 20 mm - 118.11 x 23.62 x 0.79 in	1,44 - 15.50 1,80 - 19.38	9,7 kg 12,1 kg
White			2400 x 600 x 20 mm - 94.49 x 23.62 x 0.79 in 3000 x 600 x 20 mm - 118.11 x 23.62 x 0.79 in	1,44 - 15.50 1,80 - 19.38	9,7 kg 12,1 kg
Black			2400 x 600 x 20 mm - 94.49 x 23.62 x 0.79 in 3000 x 600 x 20 mm - 118.11 x 23.62 x 0.79 in	1,44 - 15.50 1,80 - 19.38	9,7 kg 12,1 kg
Concrete Grey			2400 x 600 x 20 mm - 94.49 x 23.62 x 0.79 in 3000 x 600 x 20 mm - 118.11 x 23.62 x 0.79 in	1,44 - 15.50 1,80 - 19.38	9,7 kg 12,1 kg
Indigo Blue			2400 x 600 x 20 mm - 94.49 x 23.62 x 0.79 in 3000 x 600 x 20 mm - 118.11 x 23.62 x 0.79 in	1,44 - 15.50 1,80 - 19.38	9,7 kg 12,1 kg
Light Grey			2400 x 600 x 20 mm - 94.49 x 23.62 x 0.79 in 3000 x 600 x 20 mm - 118.11 x 23.62 x 0.79 in	1,44 - 15.50 1,80 - 19.38	9,7 kg 12,1 kg
Sand Grey			2400 x 600 x 20 mm - 94.49 x 23.62 x 0.79 in 3000 x 600 x 20 mm - 118.11 x 23.62 x 0.79 in	1,44 - 15.50 1,80 - 19.38	9,7 kg 12,1 kg
Walnu			2400 x 600 x 20 mm - 94.49 x 23.62 x 0.79 in 3000 x 600 x 20 mm - 118.11 x 23.62 x 0.79 in	1,44 - 15.50 1,80 - 19.38	9,7 kg 12,1 kg
Brown Oak			2400 x 600 x 20 mm - 94.49 x 23.62 x 0.79 in 3000 x 600 x 20 mm - 118.11 x 23.62 x 0.79 in	1,44 - 15.50 1,80 - 19.38	9,7 kg 12,1 kg
Dark Oak			2400 x 600 x 20 mm - 94.49 x 23.62 x 0.79 in 3000 x 600 x 20 mm - 118.11 x 23.62 x 0.79 in	1,44 - 15.50 1,80 - 19.38	9,7 kg 12,1 kg
Light Oak			2400 x 600 x 20 mm - 94.49 x 23.62 x 0.79 in 3000 x 600 x 20 mm - 118.11 x 23.62 x 0.79 in	1,44 - 15.50 1,80 - 19.38	9,7 kg 12,1 kg
Grey Oak			2400 x 600 x 20 mm - 94.49 x 23.62 x 0.79 in 3000 x 600 x 20 mm - 118.11 x 23.62 x 0.79 in	1,44 - 15.50 1,80 - 19.38	9,7 kg 12,1 kg

## Tolerances

Tolerances: +/- 1mm (0.04 inches). Squareness: Length/width +/- 1mm (0.04 inches). Weight +/- 10%

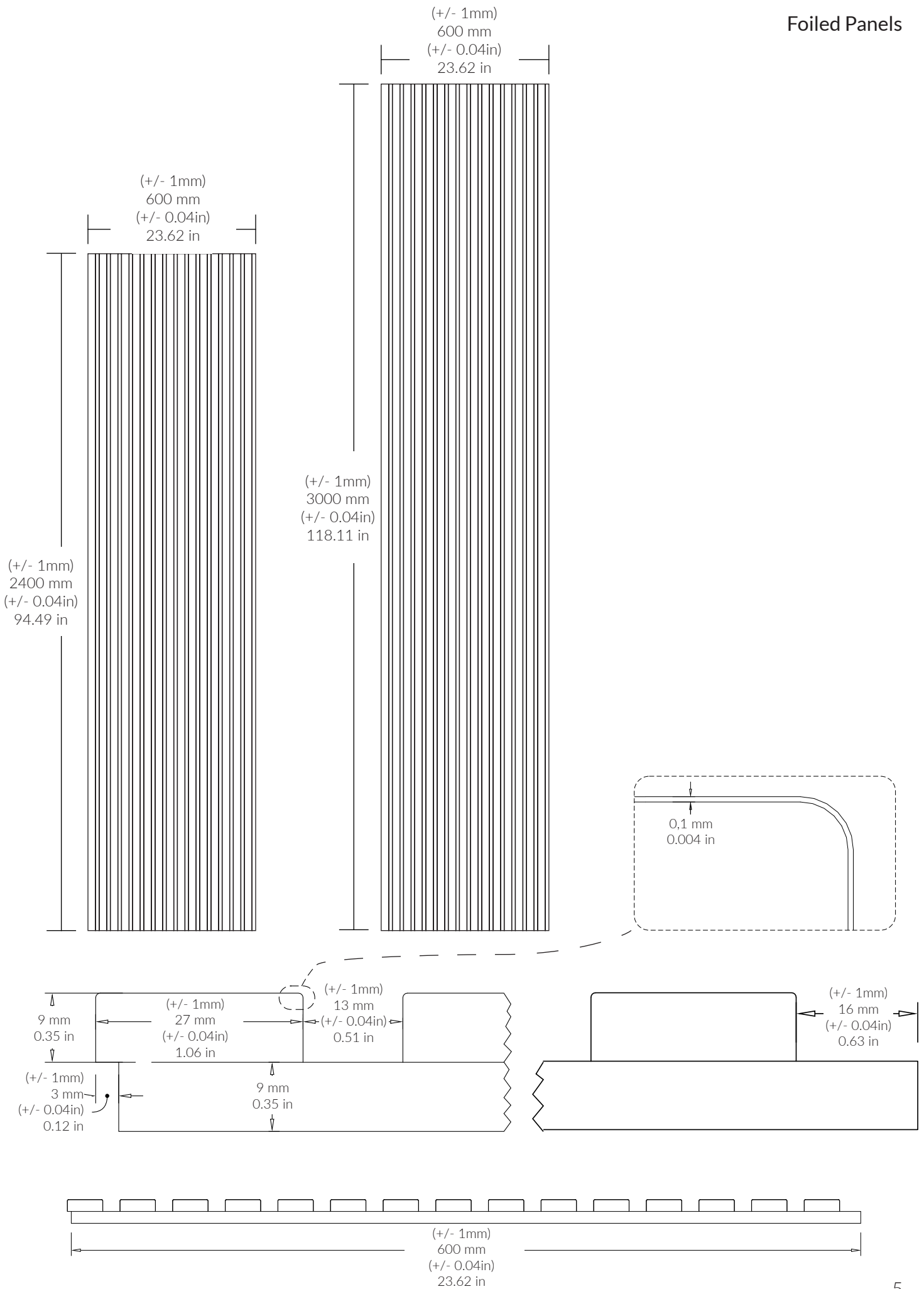

# Acoustic Measurements

Sound test according to DS/EN ISO 354:2003

## Sound test with 45mm air behind the panel

Test area: 10,8 m<sup>2</sup>  
 Room volume: 215 m<sup>3</sup>  
 Room surface area: 305 m<sup>2</sup>

Frequency [Hz]	$\alpha_s$
100	0.09
125	0.22
160	0.30
200	0.53
250	0.56
315	0.87
400	0.99
500	0.97
630	0.97
800	1.02
1k	1.02
1.25k	0.91
1.6k	0.90
2k	0.87
2.5k	0.80
3.15k	0.81
4k	0.77
5k	0.71

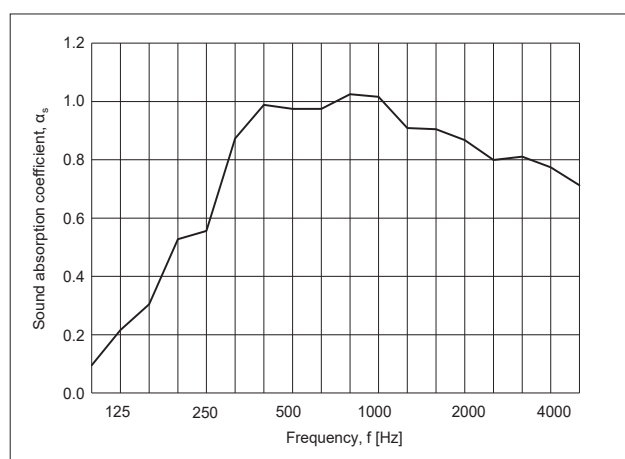

Figure 1: Sound test mounted with 45mm air behind the panel. Closed frame around the edge.

## Sound test with direct wall mounting

Test area: 10,8 m<sup>2</sup>  
 Room volume: 215 m<sup>3</sup>  
 Room surface area: 305 m<sup>2</sup>

Frequency [Hz]	$\alpha_s$
100	0.02
125	0.02
160	0.02
200	0.05
250	0.05
315	0.11
400	0.16
500	0.26
630	0.32
800	0.46
1k	0.63
1.25k	0.78
1.6k	0.97
2k	1.11
2.5k	1.05
3.15k	0.88
4k	0.75
5k	0.68

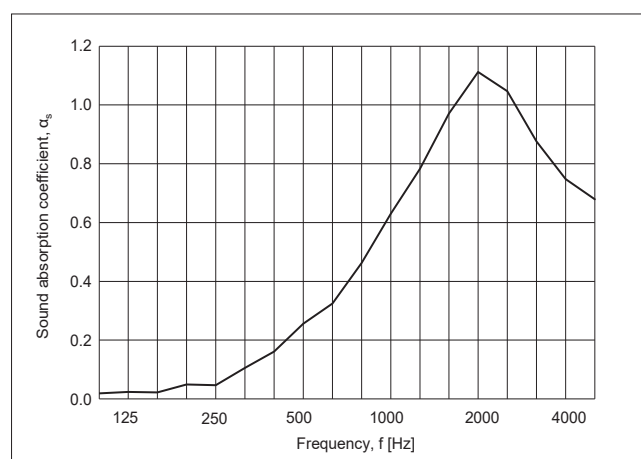
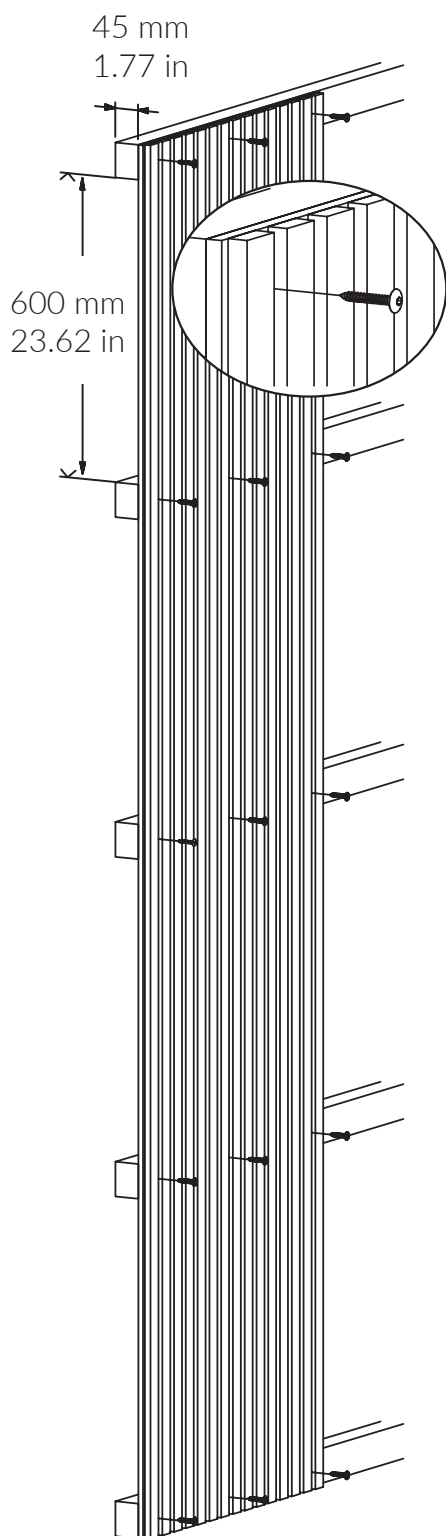

Figure 2: The sound test shows direct wall mounting.

### Tests:

Formaldehyde test: Danish Technological Institute  
 Indoor climate test: Danish Technological Institute  
 Acoustic test: Danish Technological Institute

# Installation Guide



## Method 1

### - Directly on the wall

**Mounting adhesive:** Apply the adhesive to the panel and place it against the wall. Ensure it is firmly pressed.

**Screws:** Screw the panel through the felt and into the wall. We recommend using 4 screws per panel. Remember to use wall plugs if your wall type requires it.

## Method 2

### - On a batten

For optimal sound absorption, set up a batten with 45 mm (1.77 in) battens on your wall. We recommend a spacing of 600 mm (23.62 in) between your battens. Insert mineral wool between the battens. Screw the panel onto the battens through the felt.

#### Panel adaptation:

If you need to customize the panels in width or length, we recommend using a plunge saw or circular saw for cutting.

#### Alternative mounting:

Nail gun diving

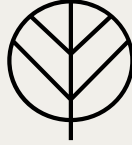

# FOG & VENØ A/S

Fog & Venø is a leading Danish manufacturer of acoustic and decorative panels with and without acoustic properties. These products are designed and manufactured with a focus on Danish craftsmanship and a constant pursuit of high quality.

The panels are suitable for installation on both walls and ceilings.

Fog & Venø has a strategic partnership with world-leading suppliers of materials such as wood veneer, linoleum, foil, and laminate, ensuring that all Fog & Venø products maintain a high standard and a wide range of options. This means that there is constantly reverberation in the room, and this is where our acoustic panels make a big difference.

Our Danish-produced acoustic panels break the sound and absorb the sound wave, so it dies out when it hits the panels. This means that the sound wave is eliminated and the reverberation time is shortened, which will improve the indoor climate and the feeling of well-being in the room, whether it is private, commercial, or public buildings we are talking about.

## Kontaktinformation

Fog & Venø A/S  
Buntmagervej 5, DK-7490 Aulum  
Tel: (+45) 88 77 83 70  
hello@fog-veno.com  
[www.fog-veno.com](http://www.fog-veno.com)