

STONE PANELS

1

PRODUCT INFORMATION



BY VENØ

STONE PANELS



BY VENØ is Danish design and acoustic panels in wood with several variants of slats for walls and ceilings in high quality.

Behind the BY VENØ brand is Fog & Venø A/S, which is responsible for all design and production. At Fog & Venø A/S, in addition to design, we also focus on the green transition in our choice of materials and handling of the product after use.

Fog & Venø produces panels in various sizes, both for private and professional actors in the construction industry.

To ensure the highest quality of our products, all panels are quality controlled during production and packing to avoid defects on acoustic panels before they are shipped to the customer.

With BY VENØ acoustic panels, you will achieve improved indoor climate and well-being in both private homes and workplaces.

2

Acoustic panels can attenuate and stop reverberation time in a room where several people are staying at the same time. With the right set-up, noise can be reduced by up to 50%.

Our acoustic panels are typically produced with a PET felt back sheet. PET felt is typically made of 50% virgin plastic and 50% recycled plastic. Our slats are either made of MDF or plywood with natural veneer glued to the front. This means that there may be shade differences in the expression of the veneer.

Why choose BY VENØ?

- Good acoustics
- Danish design
- Danish quality product
- Healthy indoor environment that promotes well-being
- Easy and quick assembly

How to create the ideal sound experience in a room.

The importance of acoustic control is underestimated in many buildings. Sound affects us in our daily lives. It can make the difference between a good and a bad day at school, work, the cinema, the theatre, etc.

Reduce noise levels effectively with BY VENØ acoustic panels.

How do you create the ideal indoor climate, both in private homes and at work?

Do you have challenges with hearing what others say when more people are in the room? The challenge

with poor acoustics, is well known and a big challenge for many people!

What is the cause of bad sound and what can we do to improve it?

Sound waves travel around the room, and each time the sound wave hits a hard surface, it is thrown back out into space, where its reverberation time becomes shorter and shorter over time. With more people, phones and small talk, there is constant reverberation in the room; this is where our acoustic panels make a big difference.

Our Danish-made acoustic panels break the sound and absorb the sound wave, so it dies out when it hits the panels. This means that the sound wave is eliminated and the reverberation time is shortened, which will improve the indoor climate and the feeling of well-being in the room, whether we are talking about private, commercial or public buildings.











All our panels are made from FSC-certified wood and veneer.





STONE PANELS specifications



|  Surface |  Core |  Felt |  Dimensions |  m ² |  Weight |
|---|--|--|---|--|--|
| Indian Autumn |  |  | 20 x 600 x 2400 mm / 0.79 x 23.62 x 94.49 in. | 1,44 | 12,3 kg |
| Tan |  |  | 20 x 600 x 2400 mm / 0.79 x 23.62 x 94.49 in. | 1,44 | 12,3 kg |
| Rustic |  |  | 20 x 600 x 2400 mm / 0.79 x 23.62 x 94.49 in. | 1,44 | 12,3 kg |

Products that fit the panel:

- Screws 4.5 x 45 mm. black
- Glue: 290ml. mounting glue



Q&A



How large an area can I cover with acoustic panels?

As a starting point, we recommend that you cover approximately 20% of the wall area or about 30% of the floor area in the room to improve the room's sound quality significantly.

Cleaning?

Our acoustic panels can be easily cleaned with a wrung damp cloth or with a vacuum cleaner.

Mounting of panels

It's super easy to install our acoustic panels. Mounting can be done directly on the wall with glue or screws - or on 45mm laths.

When mounting with screws, we recommend 15 screws per panel (4.5x45mm) for a panel length of 240cm (18-21 pcs for 300/360cm)

See assembly drawing on page 6.

Tolerances/Deviations from specified dimensions

Tolerances: +/- 3mm.

Angularity: length/width +/- 2mm.

Weight +/- 10%

Our slats are either made of MDF or plywood, with real veneer glued to the front. This means that there may be shade differences in the expression of the veneer.

Disposal/Recycling:

Sustainability is an important part of our DNA. Therefore, we have focused on making the handling of our panels after use as simple as possible (see illustration to the right).

1. The felt (backing) is removed from the slats and disposed of as plastic waste, which can be recycled.

2. The slats are sorted as recycled wood, which can be recycled into new materials.

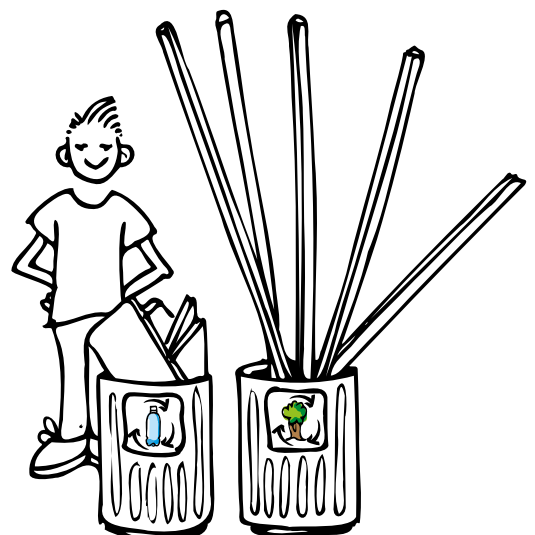
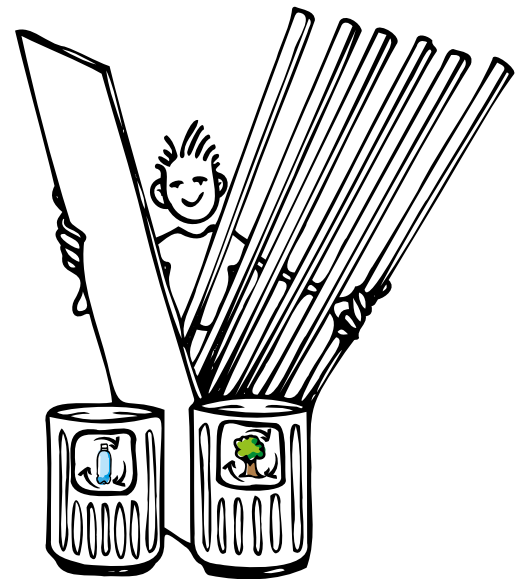
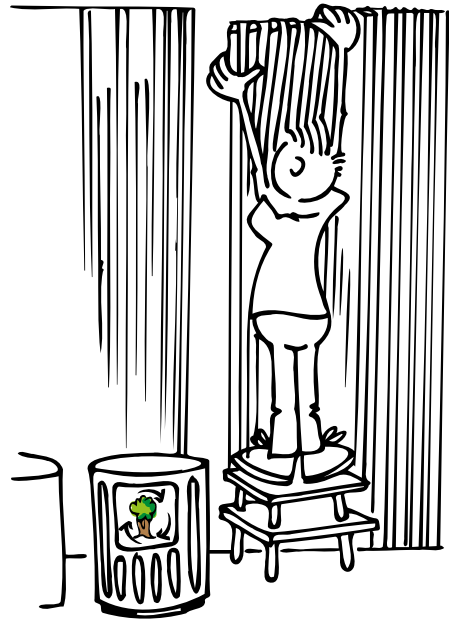

Panel mounting



Figure 1:

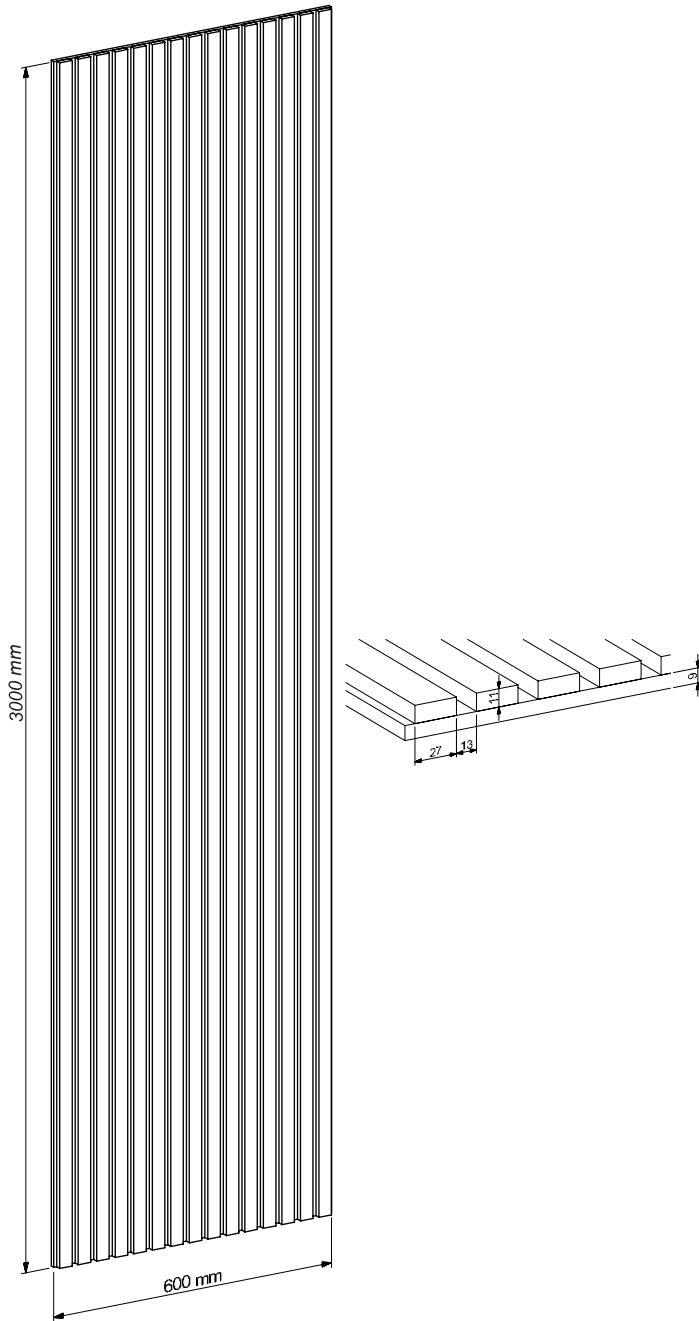

6

| Milimeters | Inches |
|------------|-----------|
| 3000 mm | 118.11 in |
| 600 mm | 23.62 in. |
| 27 mm | 1.06 in. |
| 13 mm | 0.51 in. |
| 11 mm | 0.43 in. |
| 9 mm | 0.35 in. |

Figure 2:

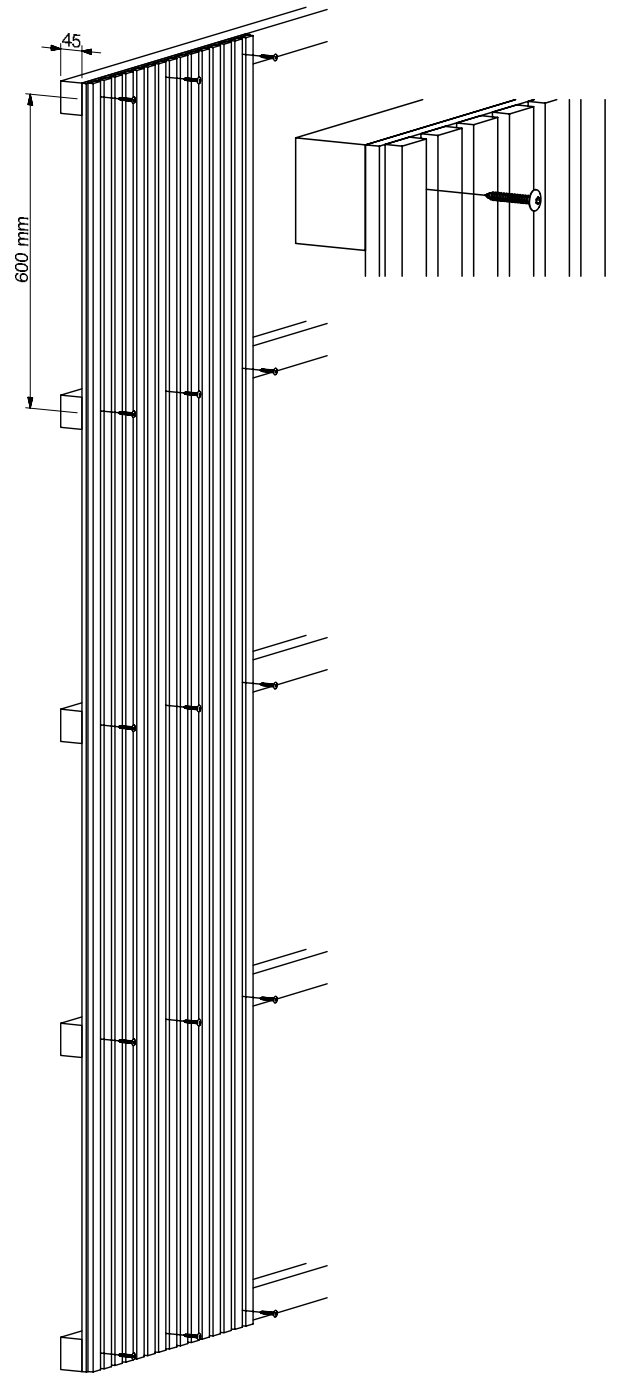

| Milimeters | Inches |
|------------|-----------|
| 600 mm | 23.62 in. |
| 45 mm | 1.77 in. |



Measurement of sound-absorption

Measurement of sound absorption coefficient acc. DS/EN ISO 354:2003

Figur 3:

Mounting: Spacing 45mm behind panels.
Closed frame around edges.

Test Area 10.8 m²
Room volume 215 m³
Room surface area 305 m³.

| Frequency [Hz] | α_s |
|----------------|------------|
| 100 | 0.09 |
| 125 | 0.22 |
| 160 | 0.30 |
| 200 | 0.53 |
| 250 | 0.56 |
| 315 | 0.87 |
| 400 | 0.99 |
| 500 | 0.97 |
| 630 | 0.97 |
| 800 | 1.02 |
| 1k | 1.02 |
| 1.25k | 0.91 |
| 1.6k | 0.90 |
| 2k | 0.87 |
| 2.5k | 0.80 |
| 3.15k | 0.81 |
| 4k | 0.77 |
| 5k | 0.71 |

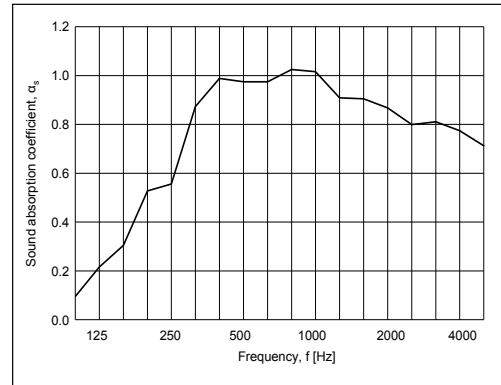

Figur 4:

Mounting: The 11 panels were laid out flat on the concrete floor in the reverberation test room.
Closed frame around edges.

Test Area 10.8 m² Sab
Room volume 215 m³
Room surface area 305 m³.

| Frequency [Hz] | α_s |
|----------------|------------|
| 100 | 0.02 |
| 125 | 0.02 |
| 160 | 0.02 |
| 200 | 0.05 |
| 250 | 0.05 |
| 315 | 0.11 |
| 400 | 0.16 |
| 500 | 0.26 |
| 630 | 0.32 |
| 800 | 0.46 |
| 1k | 0.63 |
| 1.25k | 0.78 |
| 1.6k | 0.97 |
| 2k | 1.11 |
| 2.5k | 1.05 |
| 3.15k | 0.88 |
| 4k | 0.75 |
| 5k | 0.68 |

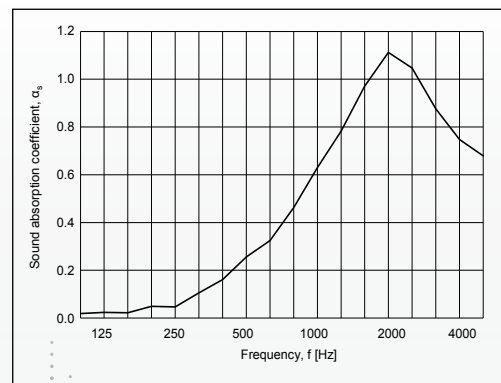

Tests:

Formaldehyde test: Danish Technological Institute
Indoor climate test: Danish Technological Institute
Sound Absorption test: Danish Technological Institute

B-S1-D0 (Applies only for polyester)



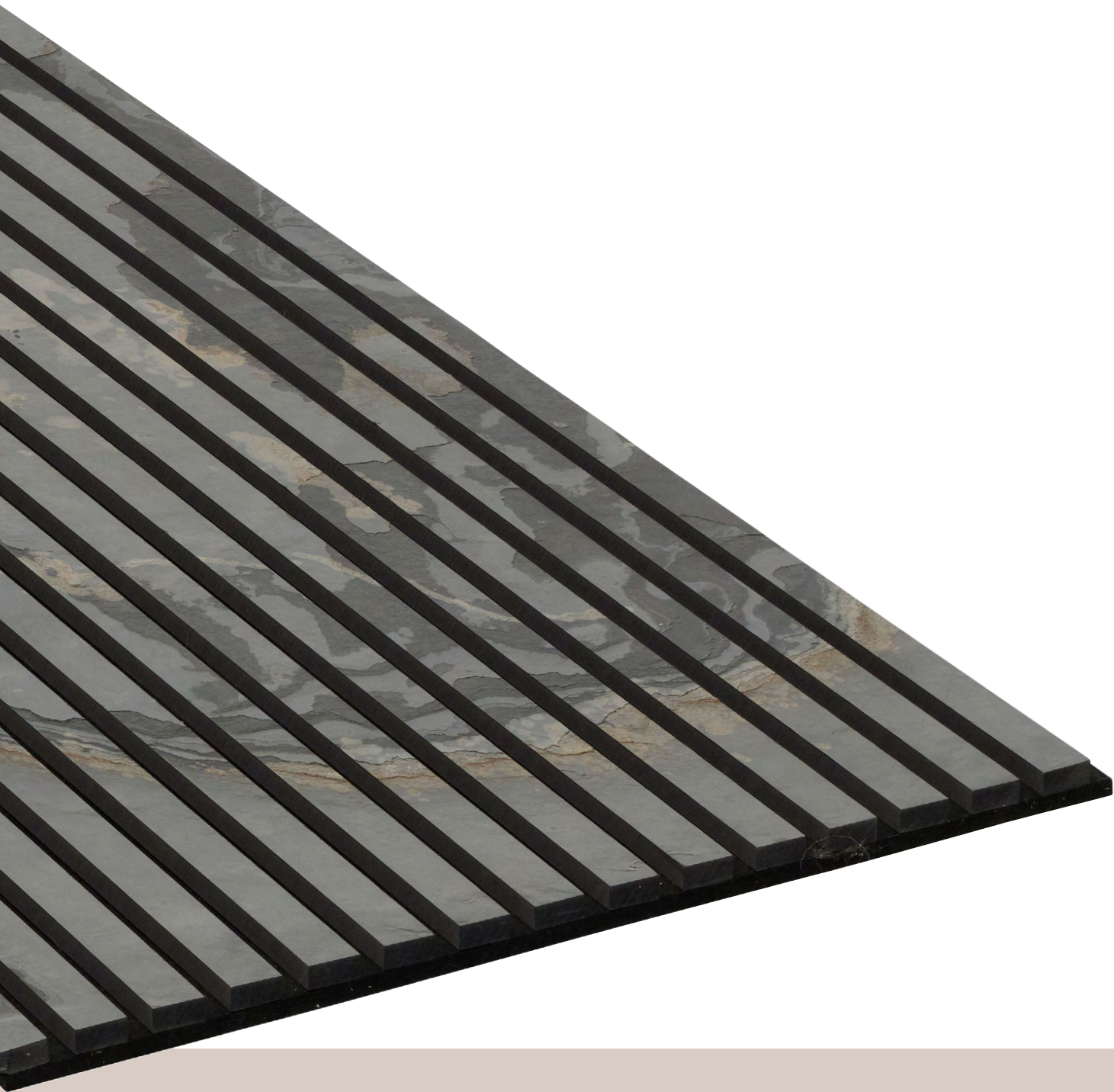

BY VENØ

Contact information:

Fog & Venø A/S
Buntmagervej 5,
DK-7490 Aulum
Tlf: (+45) 88 77 83 70
hello@fog-veno.com
www.byveno.com